

# *TECHNICAL INFORMATION*

## CITIZEN QUARTZ

### Cal. No. 898※



[CAL. 8980/8981]

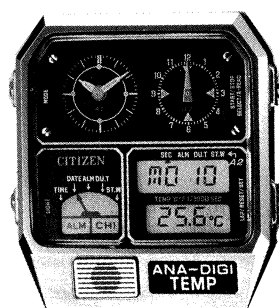

[CAL. 8982]

## CONTENTS

	Page
■1. OUTLINE .....	1
■2. FEATURES .....	1
■3. SPECIFICATIONS .....	3
■4. HANDLING INSTRUCTIONS .....	4
■5. NOTES ON MEASUREMENT OF TEMPERATURE .....	14
■6. DISASSEMBLY/ASSEMBLY OF MODULE .....	15
■7. NOTES ON ASSEMBLY/DISASSEMBLY .....	17
■8. TROUBLESHOOTING AND ADJUSTMENT .....	19

### ■1. OUTLINE

The quest for a combination watch having multiple functions gave birth to these watches.

By adding a thermometer and a 1/1000 sec. stopwatch both digitally displayed, and also including two step motors in the analog section, even more functions became available in these watches.

They are known as Caliber 8980, 8981 and 8982. The first two have a temperature sensor located near the crystal glass. The last one's temperature sensor is placed inside the case at the bottom of the face at 6 Hour mark.

This is a sporting watch with water-resistance up to 10 atmospheres of pressure.

### ■2. FEATURES

#### a) Thermometer system

A high-accuracy thermistor thermometer is incorporated. The resolution of measurement is 0.1°C or 1°F along with a centigrade-Fahrenheit switching function (with Cal. No. 8980 only).

Furthermore a "temp. Memory" functions to store the temperature every day at a certain moment of time.

#### b) Twin analog watches

Two analog watches are available with two hands and a single hand respectively owing to the use of two step motors.

The single-hand analog watch is capable of various standard indications plus a second indication.

#### c) 1/1000 sec. stopwatch

A 1/1000 sec. stopwatch is incorporated for the first time among Citizen digital watches.

---

### ■3. SPECIFICATIONS

Caliber No.		8980-04	8981-04	8982-04
Type		Combination quartz watch		
Size of module (mm)		26 x 26 x 4.05 <sup>t</sup> (Power cell part 4.28 <sup>t</sup> )	27.4 x 31.2 x 4.05 <sup>t</sup> (Power cell part 4.28 <sup>t</sup> )	
Accuracy		±15 sec./month at normal temperatures		
Oscillation		32,768Hz		
Display method		FE-type nematic LC (liquid crystal) & 3-split multiplex drive		
Converter		Bipolar step motor		
Integrated circuit		C/MOS—LSI (1 unit)		
Effective temp. range		-10°C ~ +60°C (14°F ~ 140°F)		
Adjustment of time rate		By trimmer condenser		
Display functions	Normal time	AM/PM, hour, minute & second		
	Calendar (Measurement of temp.)	Day, date & temp. (See thermometer.)		
	Alarm (Temp. memory)	AM/PM, hour, minute & storage of temp.		
	Dual time	AM/PM, hour, minute, second & L (Local time mark)		
	Stopwatch	Hour (2nd analog): minute, second & 1/100 sec. (Unit time of measurement: 1/100 sec. with 12-hour display)		
	Chime	Display of set mark only		
	1st analog	Hour & minute		
	2nd analog	Second, alarm & dual time with operation of push-buttons in modes excepting stopwatch mode		
Additional functions		<ul style="list-style-type: none"> <li>●Fully automatic calendar (1980 ~ 2019)</li> <li>●Power cell life indicator</li> <li>●Electromagnetic correction system</li> <li>●Illumination lamp</li> <li>●Alarm monitor</li> <li>●12/24 hour switching function</li> <li>●Instant manual return</li> <li>●Auto-return</li> </ul>		
Power cell (Silver oxide)		Parts No. : 280-30 (1 unit), Ag <sub>2</sub> O/KOH Cell code : SR1120W Voltage : 1.55V Capacity : 55mAH (High capacity product) Size (mm) : 11.6φ x 2.1 <sup>t</sup> Lifetime : About 2 years (20 sec. alarm, 24 hourly chimes & 3 sec. illumination of lamp per day in second mode of 2nd analog)		
Thermometer	Sensor part	Use of thermistor		
	Measurement range of temp.	-9.9°C ~ +59.9°C (14°F ~ 139°F)		
	Accuracy	±1°C (±2°F) at 20°C ~ 30°C (36°F ~ 86°F) ±2°C (±4°F) at -5°C ~ +40°C (23°F ~ 104°F)		
	Resolution	1.0°C (1°F)		
	Others	Centigrade-Fahrenheit switching function & measurement sampling time switching function (Cal. 8980/8982) <span style="float: right;">Measurement sampling time switching function (Cal. 8981)</span>		
Remarks		Product code No.: A (Reflecting plate is (silver color) B (Reflecting plate is (gold color)		

\* Cal. No. 8981 lacks only the Centigrade—Fahrenheit switching function compared with Cal. No. 8980.

4. HANDLING INSTRUCTIONS

(Note: The circle marks in the following diagrams show the flashing.)

4.1 Nomenclature and functions of push-buttons

[CAL. 8980/8981]

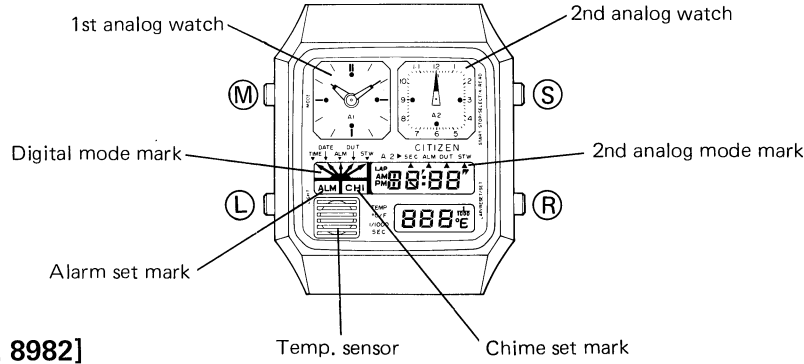

[CAL. 8982]

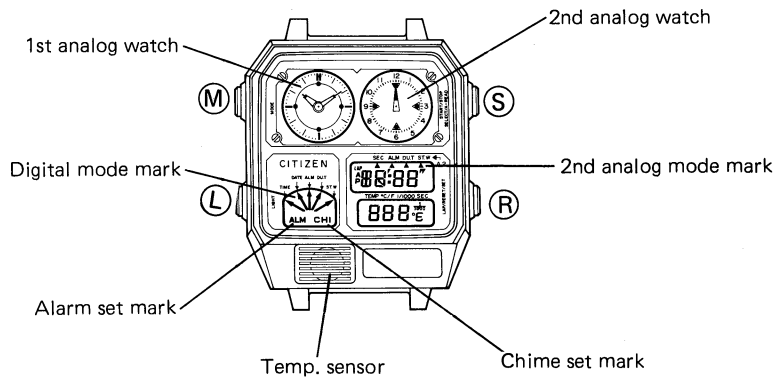

- (M) button: Switching of mode & instant manual return
- (S) button: Selection of digit for correction, switching of 2nd analog mode & start/stop (stopwatch)
- (R) button: Correction, alarm ON/OFF, switching of sampling time for temp. measurement (1 sec./1 min.), lap & reset (stopwatch)
- (L) button: Illumination lamp

4-2. Switching of 2nd analog mode

The 2nd analog modes are switched as follows excepting the stopwatch mode.

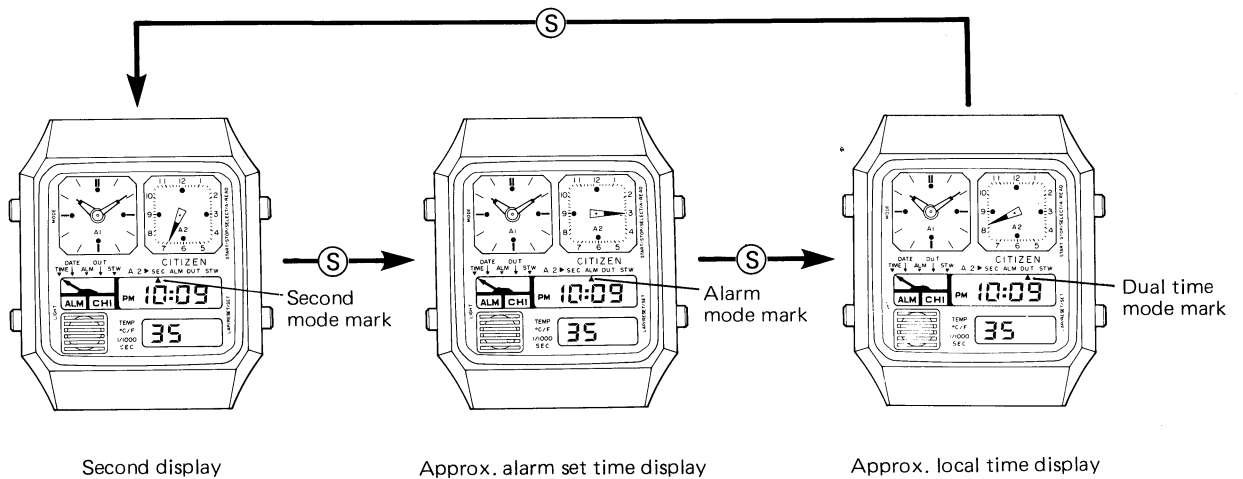

\* This is a switching example on the time display.

4-3. Switching of digital modes

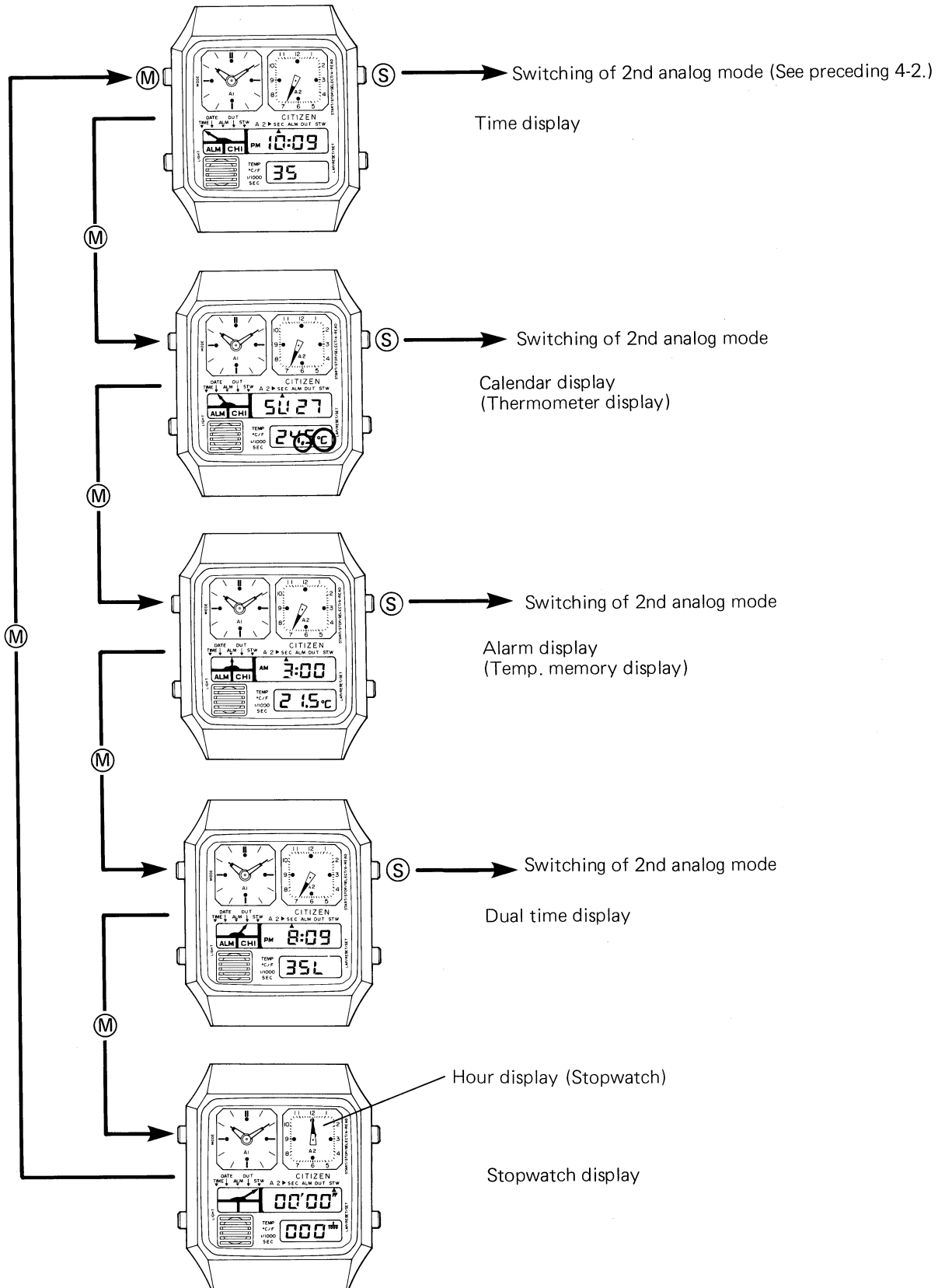

4.4. Time setting procedure

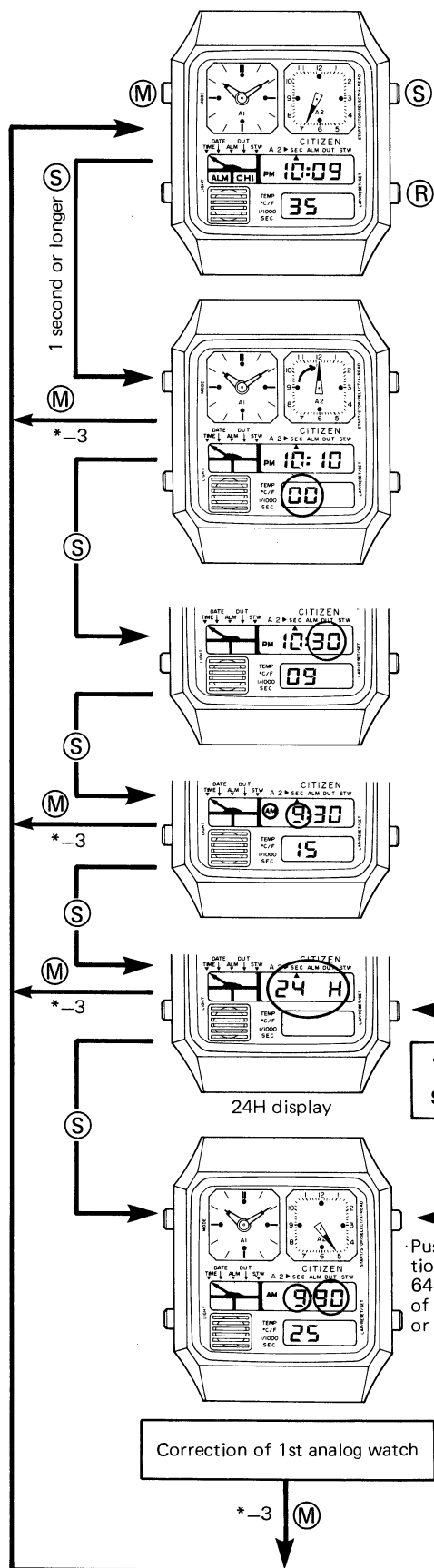

**Time display**

- A time setting mode is obtained by pushing (S) button 1 second or longer. The second can be forcibly displayed in any mode with the 2nd analog watch.\*-1

**Zero-second reset**

- The second is reset to zero with push of (R) button. (29-cut/30-count, instant zero-second reset) The analog watch is also corrected synchronously with the digital watch. A shift if caused to the position of the zero-second reset (2nd analog watch) must be corrected later.\*-2

**Setting of minute**

- The minute is set by (R) button. A quick setting of 8Hz is possible with push of (R) button for 1 second or longer.

**Setting of hour**

- The hour is set by (R) button. A quick setting of 8Hz is possible with push of (R) button for 1 second or longer.

**12H/24H display switch**

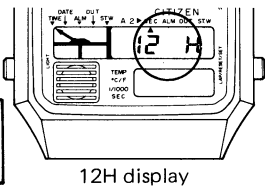

• Push (R) button for correction. A quick correction of 64Hz is possible with push of (R) button for 1 second or longer.

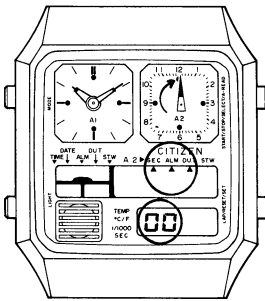

Push (R) button to set the 2nd analog watch at the 12-o'clock position. A quick correction of 8Hz is possible with push of (R) button for 1 second or longer.

Correction of 1st analog watch

Correction of zero-second reset position for 2nd analog watch

\*-2

\*-3 (M)

(S) or (M) \*-3

- \*-1: The second display mode is obtained in any mode of the 2nd analog watch and even before or after a correction.
- \*-2: A correct zero-second reset is impossible if the second hand of the 2nd analog watch is not set at a correct position. Thus the positioning of the second hand is carried out in a correction mode for zero-second reset position of the 2nd analog watch. The timing is kept even in this positioning action. In other words, if the zero-second reset is previously done, a correct second is obtained after the ordinary time mode is reset.

(Ex.)

Processing of correct second:

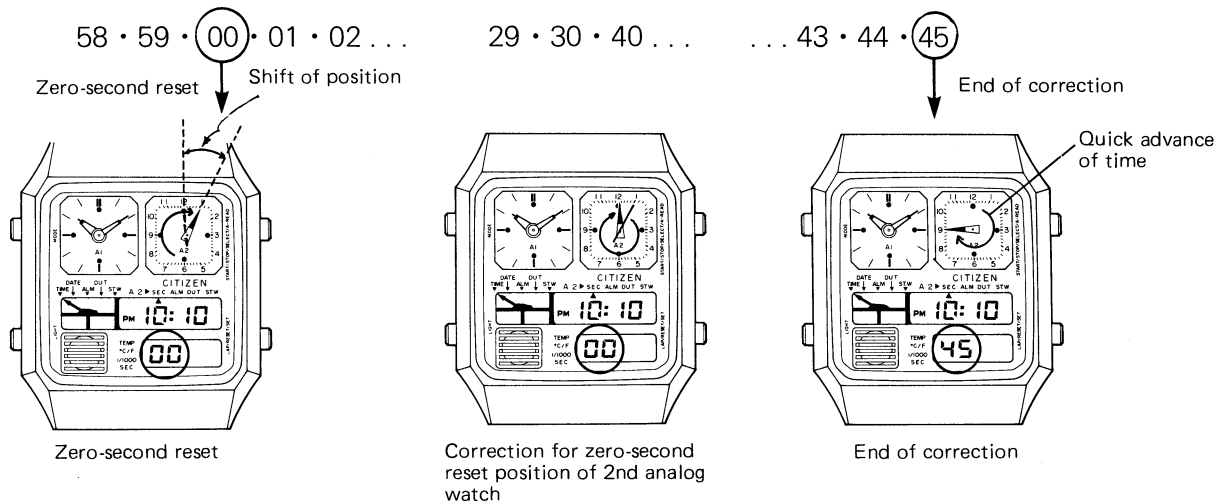

No setting is required for the position of zero-second reset of the 2nd analog watch as long as it is once set correctly.

- \*-3: The ordinary time display is reset in any mode of correction by pushing (M) button. (Instant manual return)
- Auto-return system  
The ordinary time display is automatically reset in 4 ~ 5 minutes in any mode of correction.

## 4-5. Calendar setting procedure

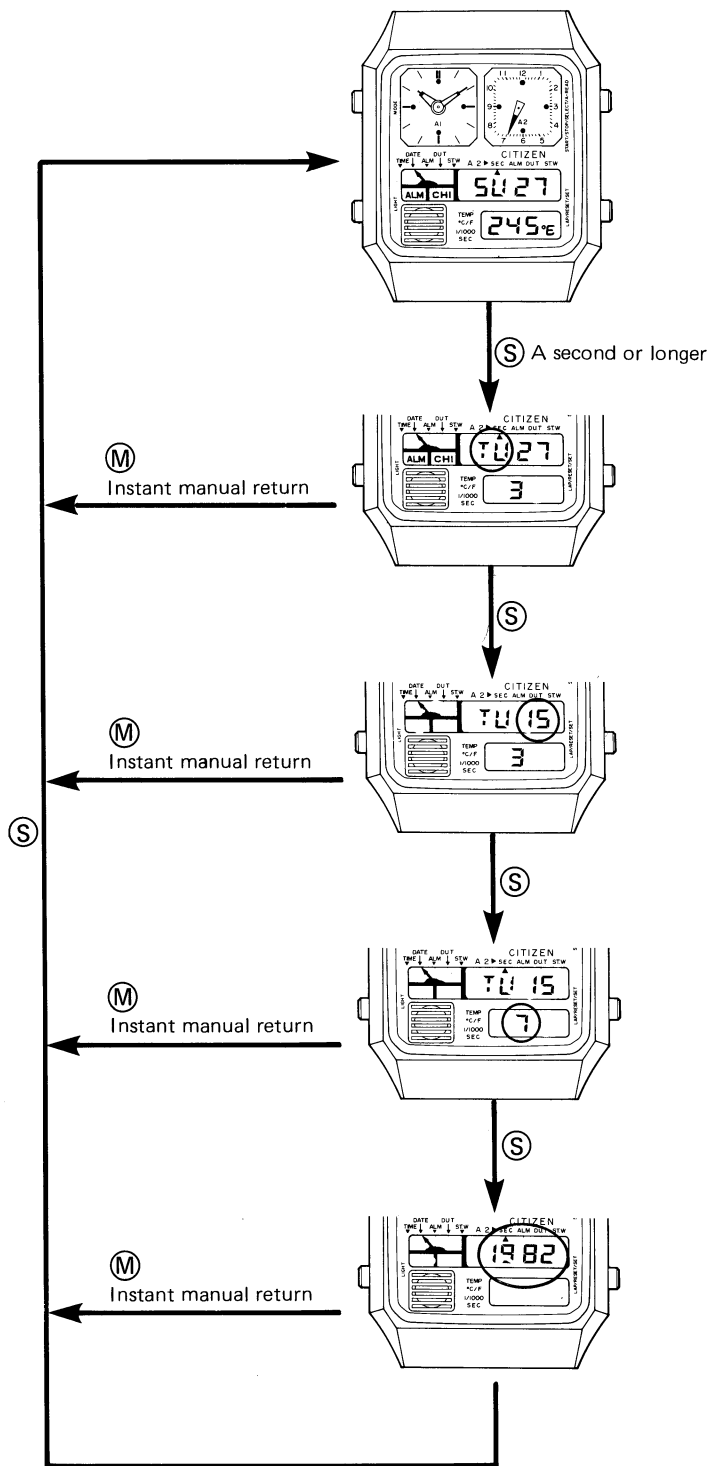
**Calendar display**

The calendar correction mode is obtained by pushing **S** button for a second or longer.

In this case, the 2nd analog watch gives a second display like in the case of the time correction.

**Setting of day**

The day is set by operating **R** button.

A quick setting (8Hz) is possible with push of **R** button for a second or longer.

**Setting of date**

The date is set by operating **R** button.

A quick setting (8Hz) is possible with push of **R** button for a second or longer.

**Setting of month**

The month is set by operating **R** button.

A quick setting (8Hz) is possible with push of **R** button for a second or longer.

**Setting of year**

The year is set by operating **R** button.

A quick setting (8Hz) is possible with push of **R** button for a second or longer.

The setting of year is possible from 1980 to 2019.

- \* The auto-return system functions in 4 ~ 5 minute if no operation is given to the push-buttons.
- \* A non-existing date, if set, is automatically corrected and changed to the first day of the following month.



#### 4-6. Operation of thermometer

The thermometer functions in the calendar display mode. The temperature can be measured in both the centigrade and Fahrenheit thermometers with every minute and every second.

a) Switching between centigrade and Fahrenheit thermometers (Cal. No. 8980)

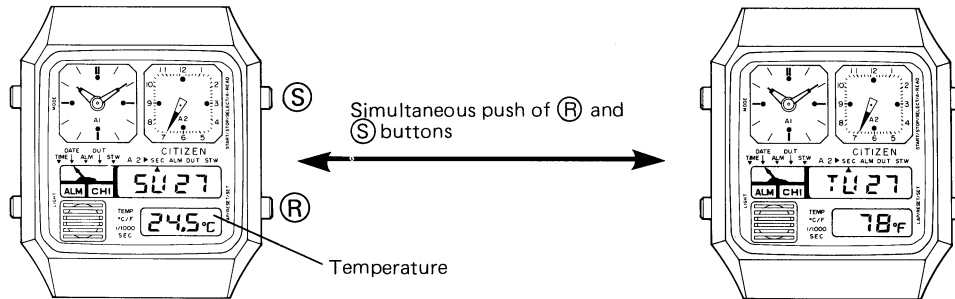

Display of centigrade thermometer ( $^{\circ}\text{C}$ )

Display of Fahrenheit thermometer ( $^{\circ}\text{F}$ )

Note: No switching is possible between the centigrade and Fahrenheit thermometers with Cal. No. 8981.

b) Switching of time units of measurement

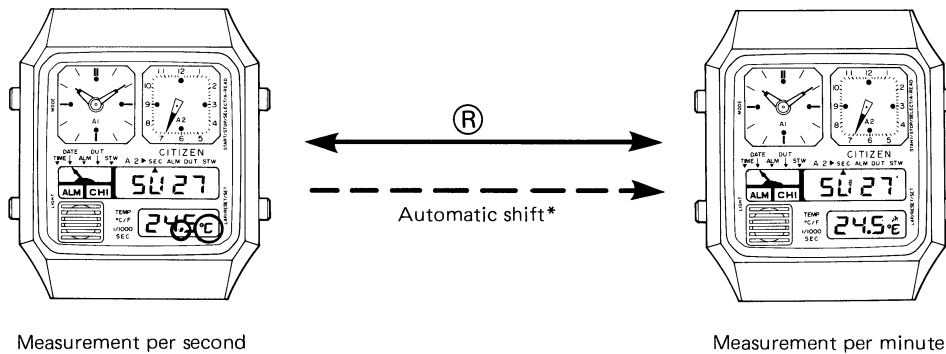

A mark  $^{\circ}\text{C}$  (or  $^{\circ}\text{F}$ ) has a flashing with every second.

A mark  $^{\circ}\text{C}$  (or  $^{\circ}\text{F}$ ) has a flashing (0.5 sec. duration) with every minute.

\* Automatic shift

The per-second measurement mode will be automatically shifted to the per-minute measurement mode in 4 ~ 5 minutes.

4-7. Operation of alarm

a) ON/OFF switching

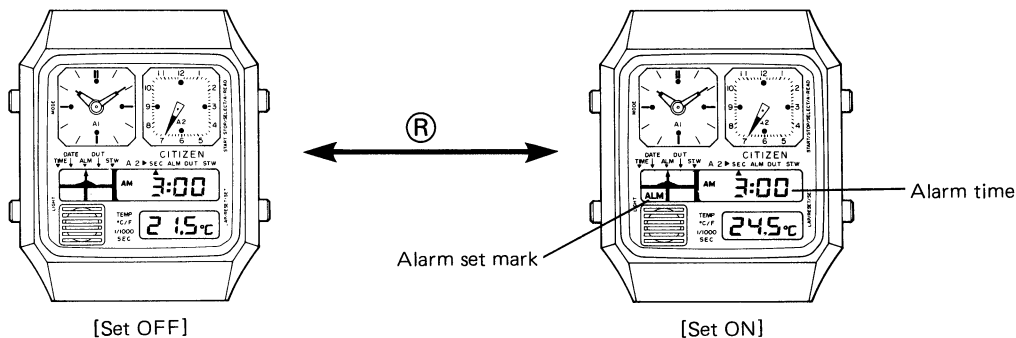

The alarm set ON/OFF is decided by the presence or absence of the alarm set mark. In the case of ON, the alarm set mark is displayed in all modes excepting the stopwatch mode.

- b) The alarm rings 20 seconds at each set time of alarm.
- c) The ringing of alarm can be stopped freely with push of any of the push-buttons.
- d) Setting of alarm time

The setting mode of alarm time is obtained by pushing (S) button for a second or longer in the alarm display mode. In this case, the 2nd analog watch is forcibly set in the approx. alarm set time display. The digit to be set is selected by (S) button, and the alarm time is set by (R) button.

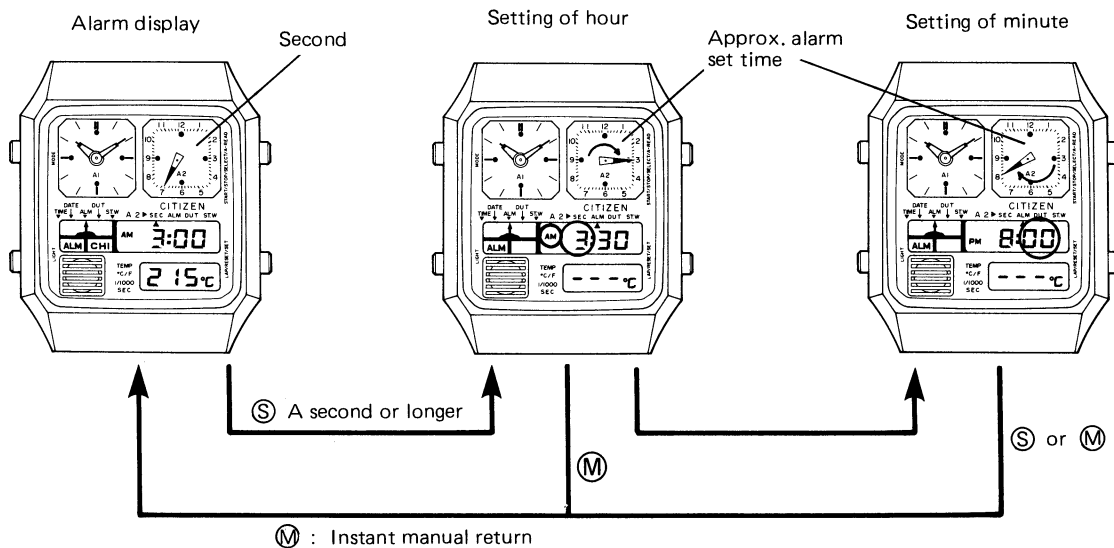

- \* A quick setting (8Hz) is possible with push of (R) button for a second or longer.
- \* The approx. alarm set time display is coupling to the digital mechanism. The approx. alarm set time display is given to the 2nd analog watch after the setting of alarm time is over. (The pointer makes a round with every 60 minutes in the correction of minute.)
- \* The alarm display is automatically reset in 4 ~ 5 minutes owing to the auto-return system.

#### 4-8. How to use temp. memory

The temp. memory stores the temperature at the moment of an alarm set time. Thus you can know the temperature at the same time every day or at a certain moment designated optionally.

A bar display which is usually given after an alarm time is set will be changed to display the temperature at the alarm set time. The data of this temperature is held for 24 hours and until at the next alarm time. (The temp. memory data is cancelled when the alarm time is changed.)

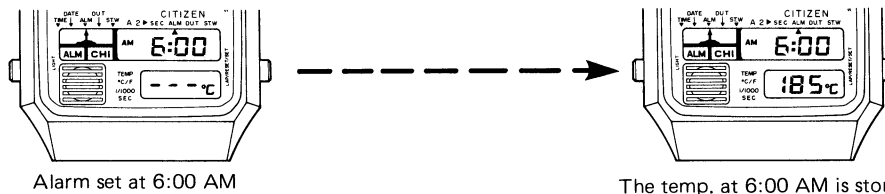

- \* A centigrade temp. is kept until the next time of measurement although the centigrade display is switched to the Fahrenheit display and vice versa. (Cal. No. 8980)

#### 4-9. How to use dual time

The dual time function is very convenient for a overseas trip or the like.

The 2nd analog watch is capable of three different displays by means of (S) button (Refer to 4-2.) and is forcibly set under the approx. local time in the correction mode of dual time.

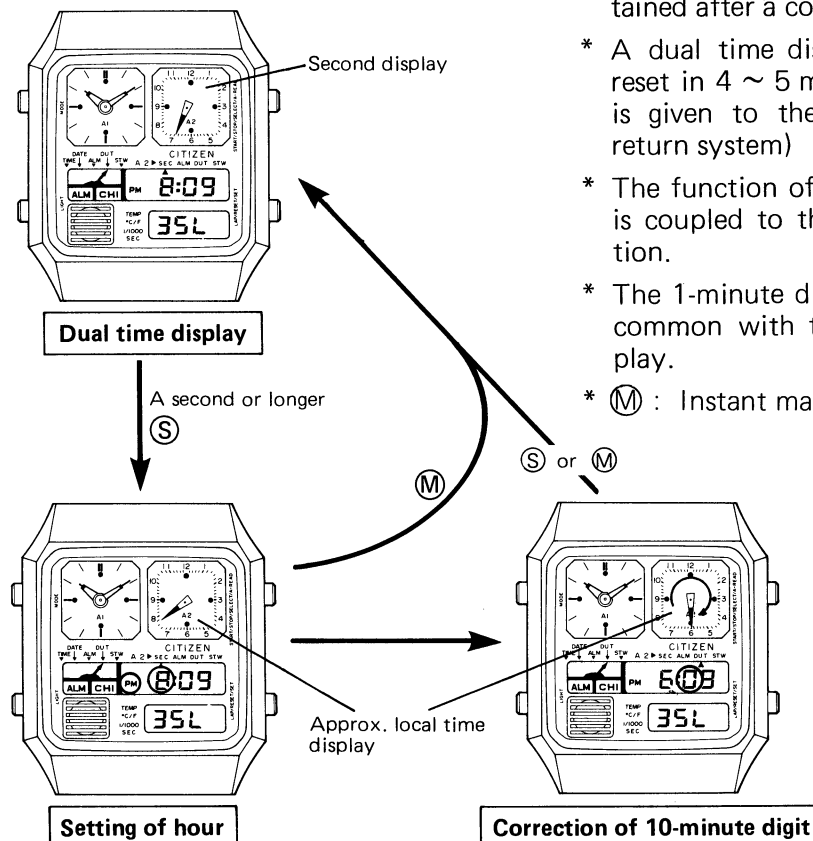

- \* An approx. local time display is obtained after a correction.
- \* A dual time display is automatically reset in 4 ~ 5 minutes if no operation is given to the push-button. (Auto-return system)
- \* The function of the 2nd analog watch is coupled to the digital watch function.
- \* The 1-minute digit and the second are common with the ordinary time display.
- \* (M) : Instant manual return

The time is set by (R) button.

A quick setting (8Hz) is possible with push of (R) button for a second and longer.

4-10. Operation of stopwatch

The operation of this stopwatch is identical with other ordinary stopwatches except for a 1/1000 sec. display and the fact that the hour is displayed on the 2nd analog watch.

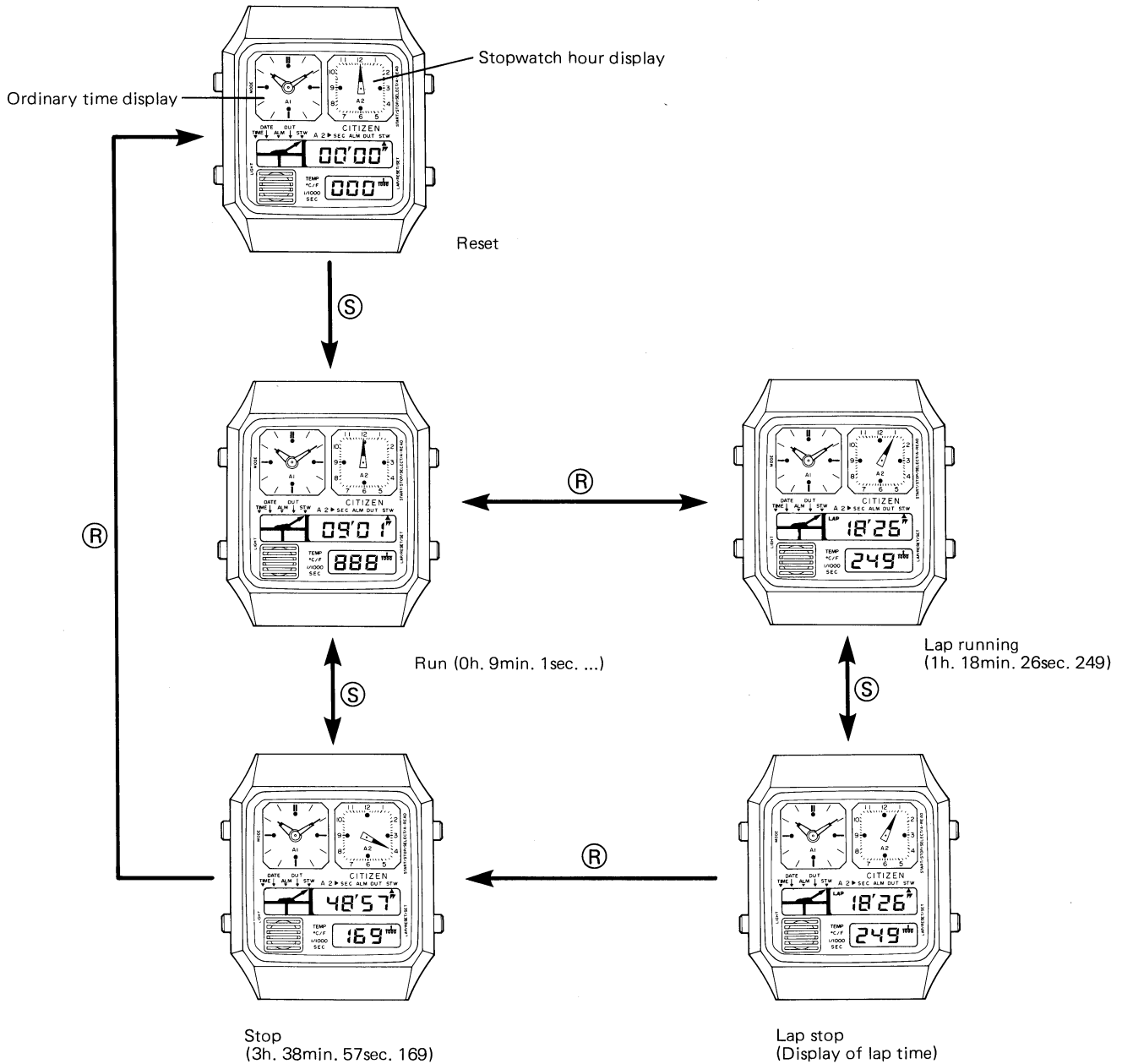

- \* When the stopwatch mode is released, the 2nd analog watch is reset to the original mode.
- \* A sound of confirmation is heard with every push of **(S)** button.

#### 4-11. Alarm monitor

A sound of alarm is produced with a simultaneous push of both (S) and (R) buttons in the mode of the ordinary time display.

#### 4-12. Chime function

##### a) ON/OFF switching

The ON and OFF of the chime function are switched alternately and every time the alarm monitor is carried out in the mode of the ordinary time display.

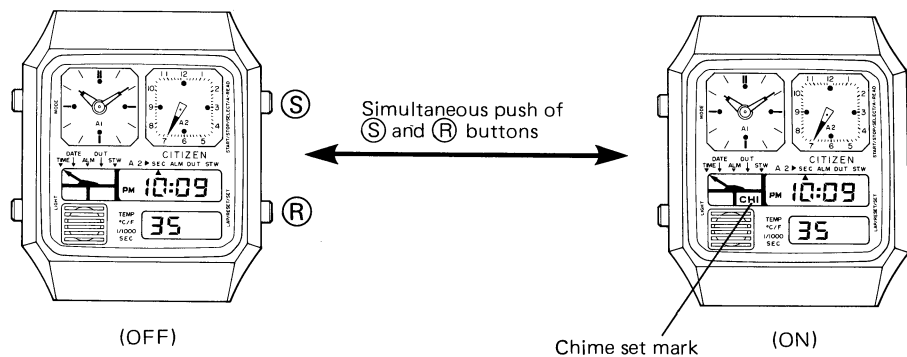

\* The chime set mark is displayed in every mode excepting the stopwatch mode when the chime function is ON.

##### b) Sound of chime

A beep sound is heard every hour on the hour as long as the chime function is ON.

#### 4-13. Power cell life indicator

The colon on the digital display screen blinks when the 2nd analog watch displays the second time and the life of the power cell comes near its end with a drop of the voltage. In such case, the power cell must be replaced soon with new one.

## ■5. NOTES ON MEASUREMENT OF TEMPERATURE

### (1) Accuracy of measurement

A watch put on a wrist is affected by the body heat, and no coincidence is obtained between the display of temperature and the room temperature. An accurate room temperature is measured in the following procedure.

- A watch is put off from the wrist and then left as it is for 20 ~ 30 minutes before the measurement of temperature. This leaving time differs according to the environment in which the watch is put and requires at least 12 minutes or so.
- The display of temperature approximates to the room temperature in an asymptotic way. The room temperature is obtained when the display of temperature has a change of about 0.1°C per minute.
- A considerable difference of temperature is produced by the place of measurement even in the same room. It is especially noticed that a big difference of temperature is produced in a showcase.

### (2) Quick measurement

The watch will easily adapt itself to the room temperature when the watch case touches an object having a high heat conductivity.

The measurement is possible in a comparatively short time if the watch is forcibly cooled by air (exposed to the wind). However, the temperature may sometimes change if the supply of wind is cut since the module of the watch does not adapt itself to the outside temperature.

### (3) Range of temperature for measurement

It must be noticed that the measurement of temperature outside a prescribed range will affect the basic function of the watch.

### (4) Comparison with other thermometers

No absolute standard is available for users in terms of the temperature. Accordingly the following notes must be noticed in case the value of indication is different from other thermometers.

- A difference of response speed exists between the thermometer of this caliber and a liquid column thermometer like an alcohol thermometer, etc. or a finished bimetal-type thermometer. Furthermore, as mentioned in (1), a big difference of temperature is caused according to the place of the thermometer and the place of the watch.
- A bimetal-type thermometer or a liquid column thermometer using the soft glass may have some variation with time to cause some error.
- For an accurate control of temperature, please contact Citizen Service Base where a standard thermometer is provided.

6. DISSASSEMBLY/ASSEMBLY OF MODULE WITH LUBRICATION

Disassembling procedure : ① → ③⑥  
 Assembling procedure : ③⑥ → ①

Marks of lubrication:  
 A—Lube oil  
 F—Lube oil

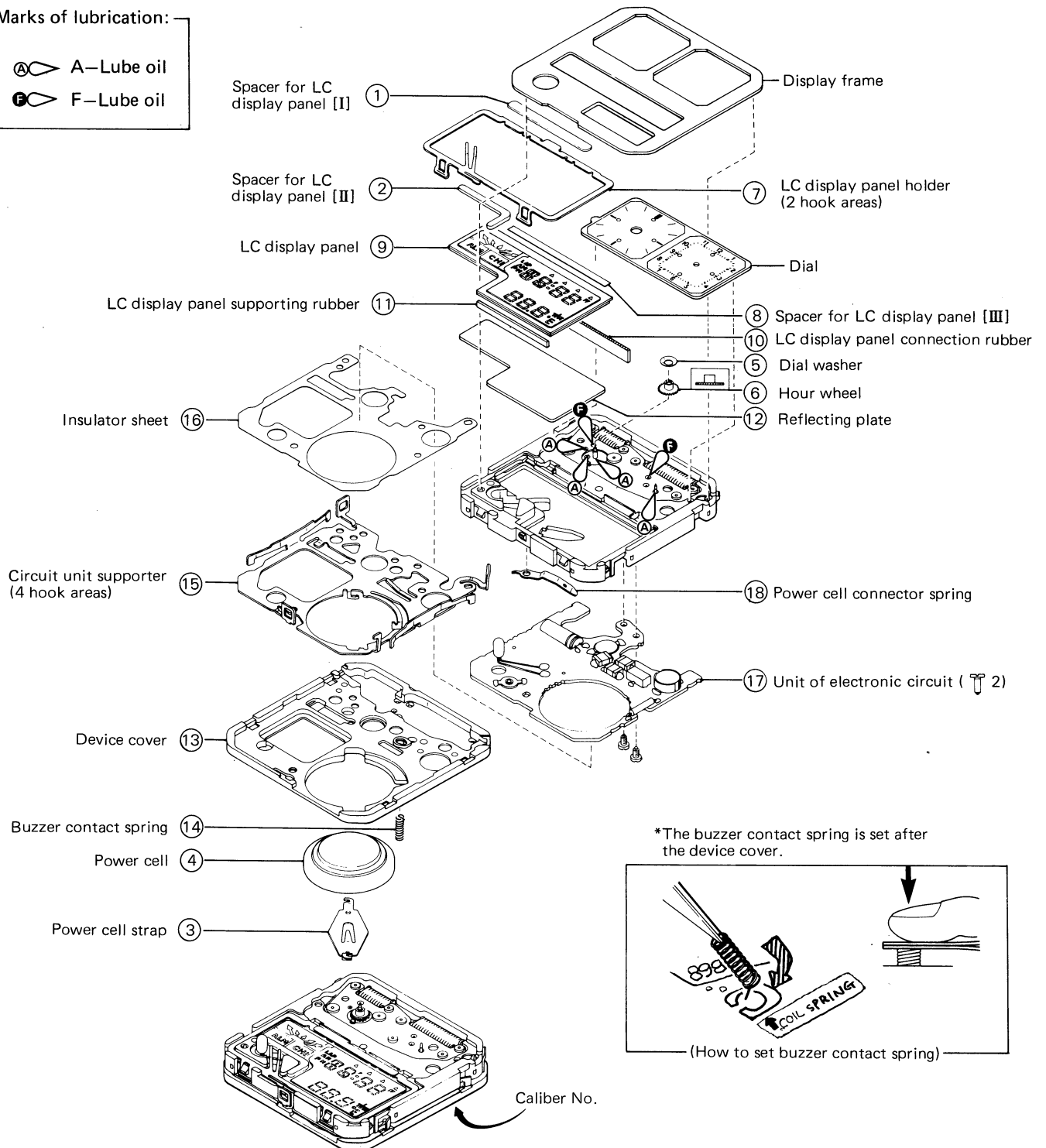

Fig. 10

(Digital section)

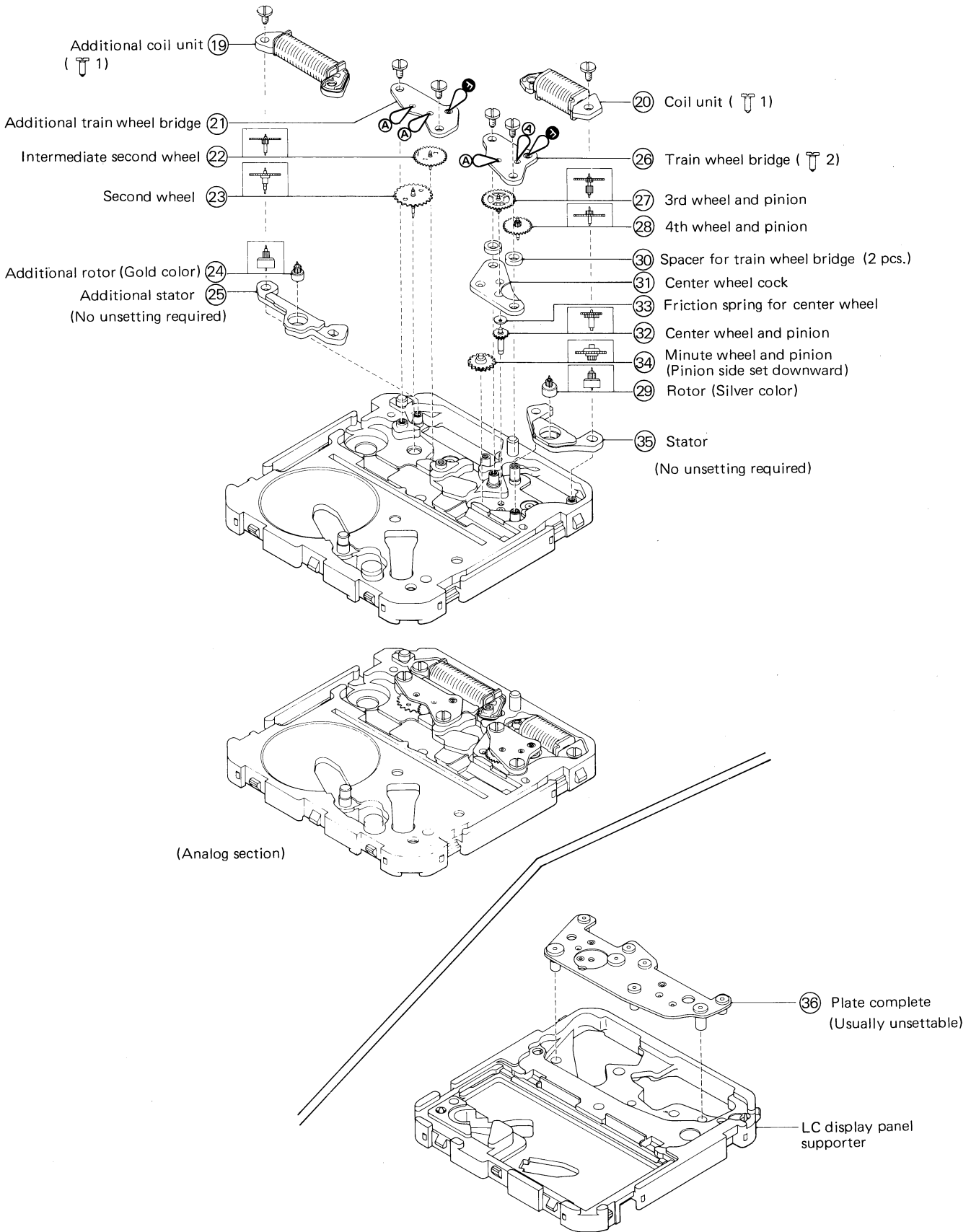

Fig. 11

(Exploded view of plate complete)



## 6. Notes on assembly/disassembly

### a) Handling of thermistor

[CAL. 8980/8981]

A malformation of the thermistor attached to a unit of electronic circuit may sometimes cause a defective setting of the module into the case. In other words, the positioning becomes incomplete for the thermistor. This may cause a defective measurement of temperature or the breakdown of the thermistor. So that a special attention must be paid to the foot of the thermistor as well as to the positioning of the thermistor when it is set into a case.

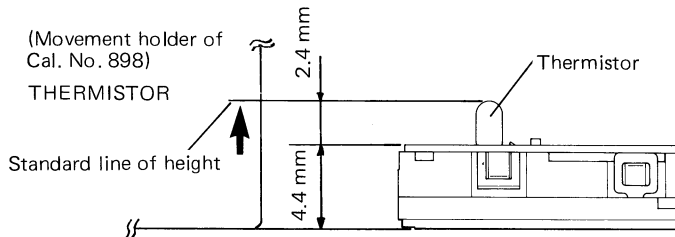

Fig. 13

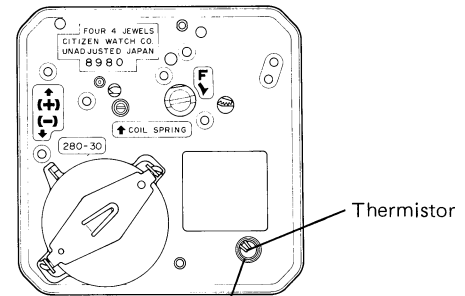
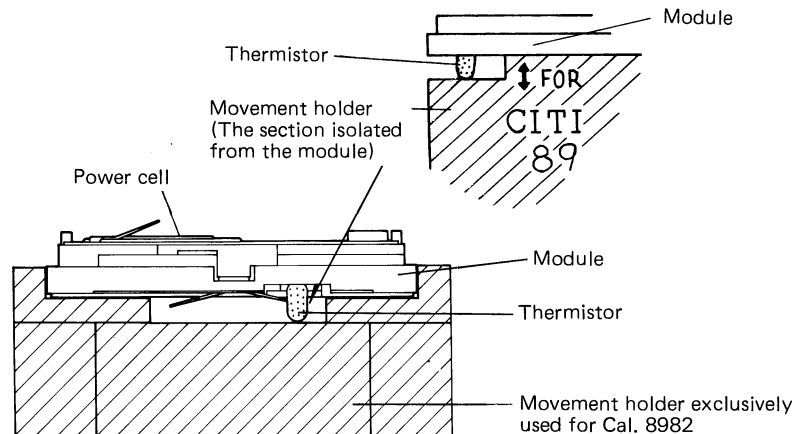

Fig. 14

Make sure the thermistor can be viewed at the center of a through-hole.

[CAL. 8982]



The above illustration is a view of the module mounted onto the movement holder with its power cell section facing upward, and the view is obtained from the direction of the bottom of the face (6 Hour mark) of the watch.

- \* The module should be mounted on the movement holder in a correct way, as illustrated above, making sure that the tip of the thermistor maintains a light contact with the upper surface of the section of the movement holder which is isolated from the module. At this time, make sure that the thermistor is almost perpendicular to the module.

- b) Hooking of LC display panel holder and circuit unit supporter.

Both the LC display panel holder and the circuit unit supporter are hooked to the LC display panel supporter.

Thus these parts are disassembled after unsetting the hooked areas by a tweezers.

- ⇨: Hooked areas (2) of LC display panel holder  
 ➔: Hooked areas (4) of circuit unit supporter

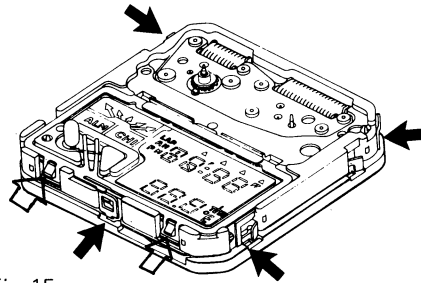

Fig. 15

- c) The parts of the train wheels and the additional train wheels are not interchangeable with each other.

The additional rotor is plated in gold color, and the round holes are drilled to the gears of the second wheel and the intermediate second wheel respectively.

- d) Spacer for LC display panel

To increase the shock resistance, the spacers for LC display panel (I, II, and III) are added to this caliber. Some of this calibers produced at an early stage of mass production lack these spacers.

The spacers for LC display panel (I) and (II) are just put on the LC display panel holder or the LC display panel, and so that be careful not to loose these spacers when the display frame is unset and on the like occasions.

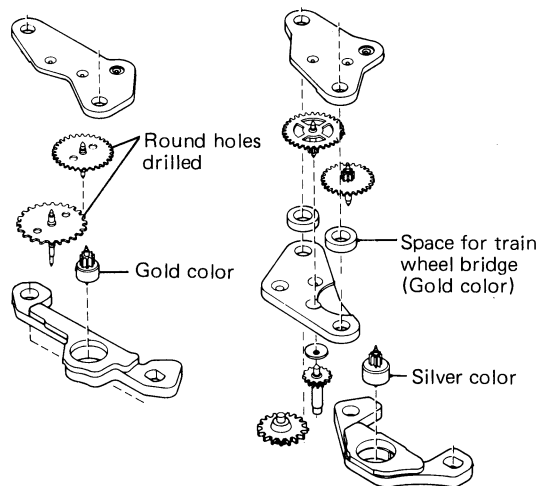

Fig. 16

### Concerning the LC display panel supporting rubber

To increase shock-resistance of the LC display panel, three pieces of the LC display panel supporting rubbers are added to this caliber.

Some of these same calibers already produced in an early stage of mass production lack the LC display panel supporting rubber.

The LC display panel supporting rubbers (I) and (II) are not attached but simply placed on the LC display panel or the LC display panel holder. So, be careful not to miss them when removing the display frame and the like.

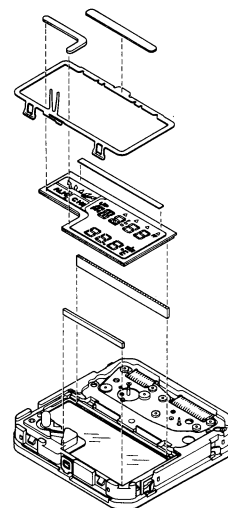

7. NOTES ON ASSEMBLY/DISASSEMBLY

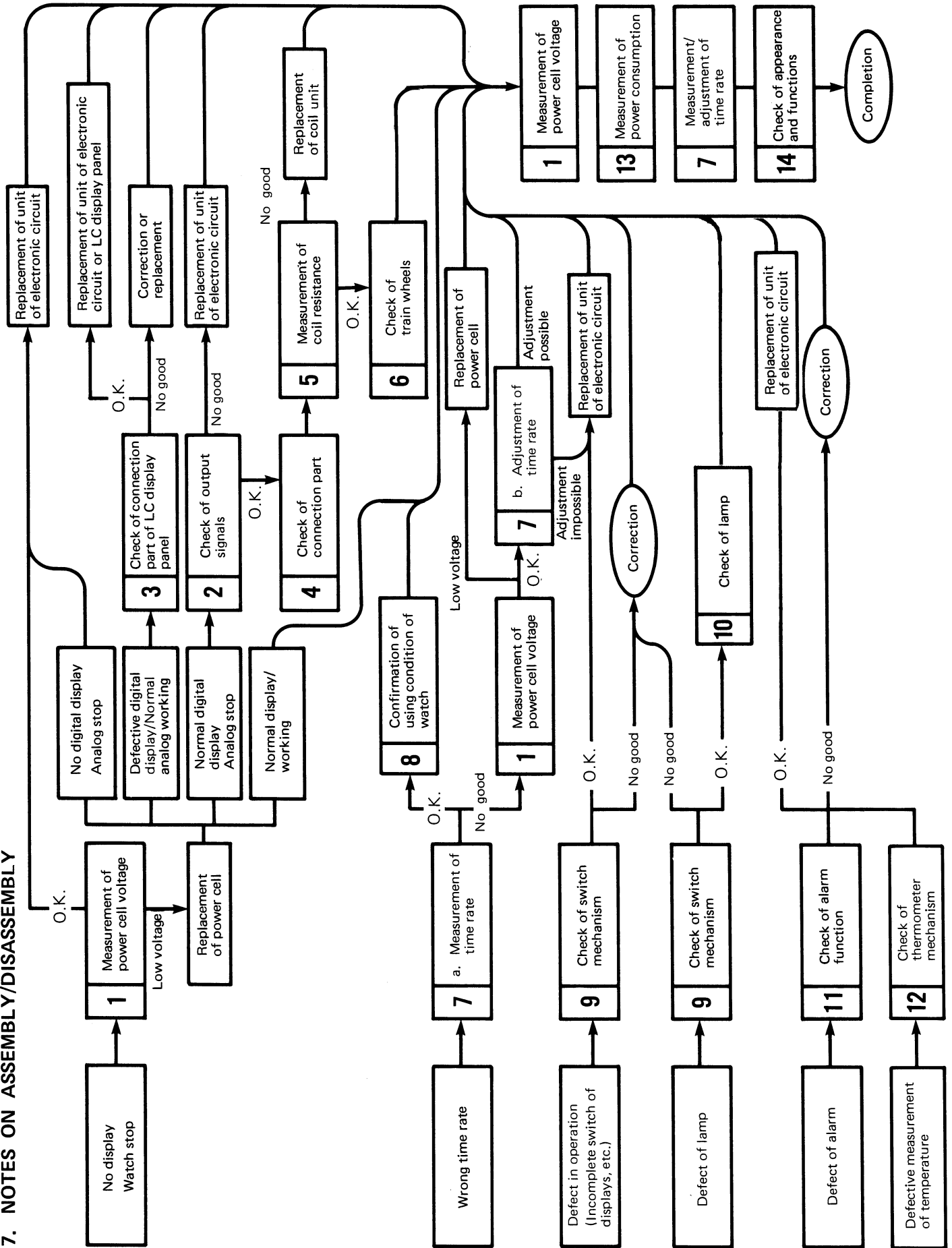

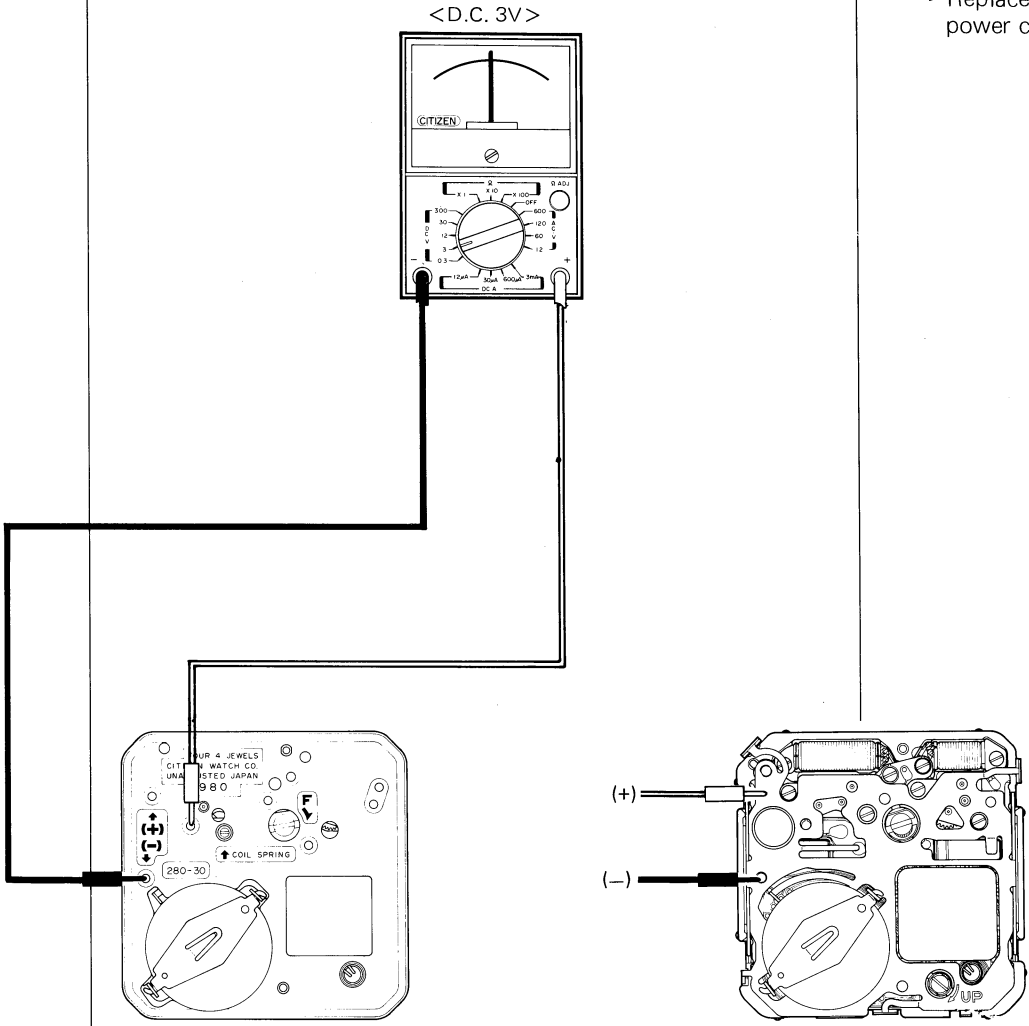
Checking items	How to check	Results and treatment
<p><b>1</b> Measurement of power cell voltage</p>	<p>An easier measurement is possible if the device cover is removed.</p> <p>The minus pattern can be viewed through the hole of a circuit unit supporter.</p> <p>And avoid a short circuit to the circuit unit supporter.</p> <div style="text-align: center;"> <p>&lt;D.C. 3V&gt;</p>  </div>	<div style="border: 1px solid black; padding: 2px; width: fit-content; margin-bottom: 10px;"> <p><b>Over 1.5V</b></p> <p>→ Nondefective</p> </div> <div style="border: 1px solid black; padding: 2px; width: fit-content;"> <p><b>Under 1.5V</b></p> <p>→ Replacement of power cell</p> </div>

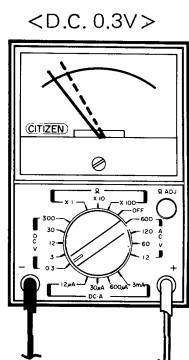
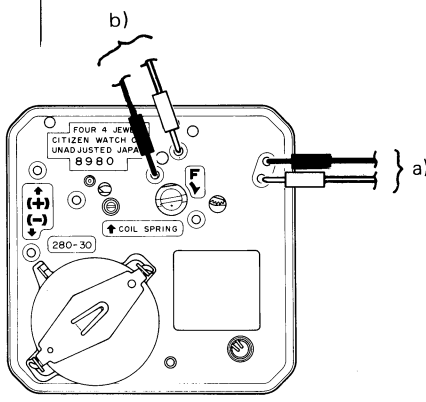
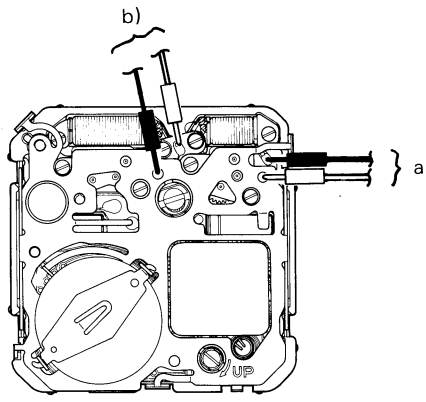
Checking items	How to check	Results and treatment
<p>2 Check of output signal</p>	<p>a) Check of 1st analog output signal                      b) Check of 2nd analog output signal</p> <p>When checking the 2nd analog output signal, the 2nd analog mode is always set at the second display.</p>  <p>Ⓢ button to be operated so that the 2nd analog mode mark (▲) comes to the position of SEC. (See Fig. 18)</p> <p>* An easier measurement is possible with removal of the device cover.</p> <p>Be careful of a short circuit caused with the circuit unit supporter if the device cover is removed.</p>   	<p>a) Tester pointer swinging right and left with every 20 sec.                      → Nondefective</p> <p>b) Tester pointer swinging right and left every second                      → Nondefective</p> <p>No output signal                      → Replacement of unit of electronic circuit</p>

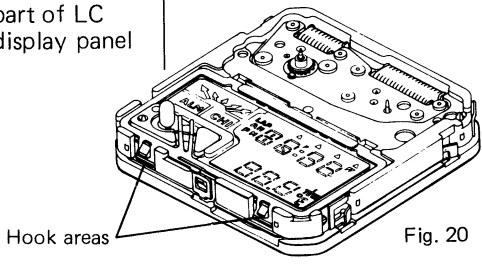
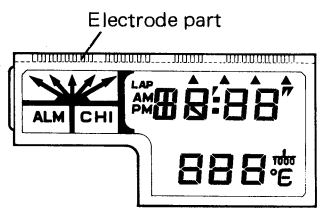
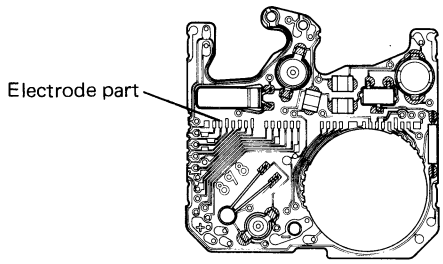
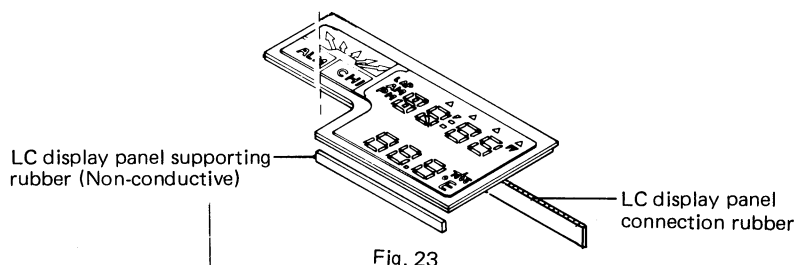
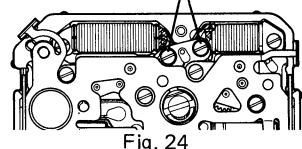
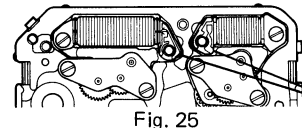
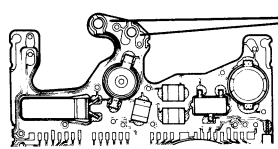
Checking items	How to check	Results and treatment
<p><b>3</b> Check of connection part of LC display panel</p>	<p>The following points are checked.</p> <p>Make sure that the LC display panel holder is set in a correct and complete way with no malfunction.</p>  <p>Fig. 20</p> <p>Make sure that the electrode part of the LC display panel is free from any stain or crack.</p>  <p>Fig. 21</p> <p>Make sure that the electrode part of the unit of electronic circuit is free from any stain or breakdown of a pattern.</p>  <p>Fig. 22</p> <p>Make sure that the LC display connection rubber is set in a correct and complete way with no wear nor twist.</p>  <p>Fig. 23</p>	<p>Defective setting → To be set again</p> <p>Malformation → Replacement of LC display panel holder</p> <p>Stains → To be cleared off</p> <p>Crack → Replacement of LC display panel</p> <p>Stains → To be cleared off</p> <p>Breakdown of pattern → Replacement of unit of electronic circuit</p> <p>Defective setting → To be set again</p> <p>Malformation of connection rubber → To be replaced</p> <p>*When no fault is detected through above checks, the LC display panel or the unit of electronic circuit is replaced after confirming the value of power consumption, etc.</p>
<p><b>4</b> Check of connection part</p>	<p>Screws for unit of electronic circuit</p>  <p>Fig. 24</p> <p>An inspection is paid to the driving condition of the screws for unit of electronic circuit as well as to the foreign matters or stains sticking to the area between the coil terminal and the analog output terminals on the rear side of the unit of electronic circuit.</p>  <p>Fig. 25</p> <p>Coil terminals</p>  <p>Fig. 26</p> <p>Output terminals</p>	<p>Screws driven loose → To be driven tight again</p> <p>Foreign matters or stains → To be removed away</p>

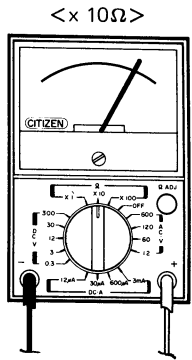
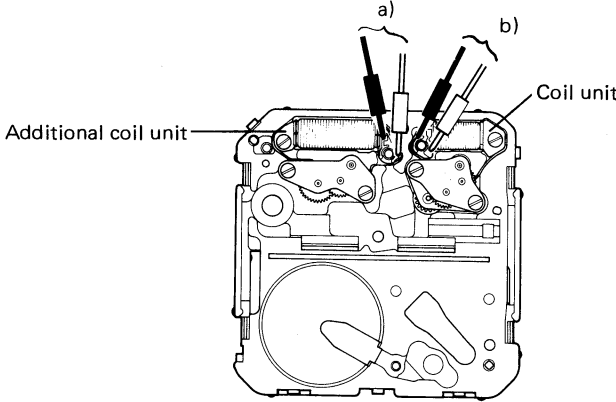
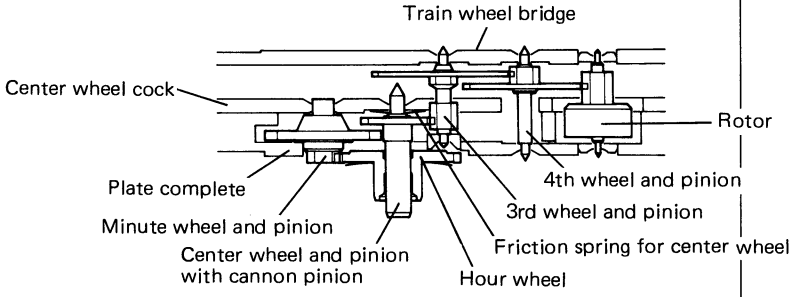
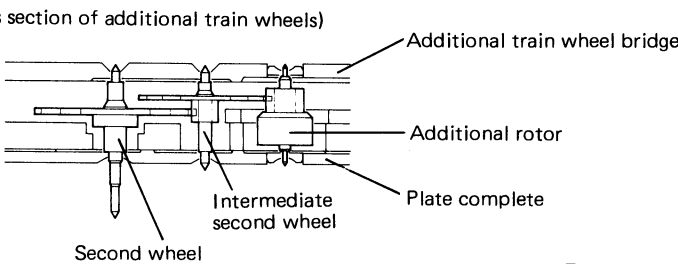
Checking items	How to check	Results and treatment
<p>5 Measurement of coil resistance</p>	<p>a) Measurement of resistance for additional coil unit b) Measurement of resistance for coil unit</p>   <p style="text-align: right;">Fig. 27</p> <p>* Avoid giving the disconnection to the coil.</p>	<p>a) Resistance value of additional coil unit: <b>2.2 ~ 2.8K<math>\Omega</math></b> → Nondefective</p> <p>b) Resistance value of coil unit: <b>0.9 ~ 1.3K<math>\Omega</math></b> → Nondefective</p> <p>Resistance value outside above ranges → Replacement of each coil unit</p>
<p>6 Check of train wheels</p>	<p>Make sure of the setting condition of each wheel plus the degree of clearance, etc.</p>  <p>(Cross section of additional train wheels)</p>  <p style="text-align: right;">Fig. 28</p>	

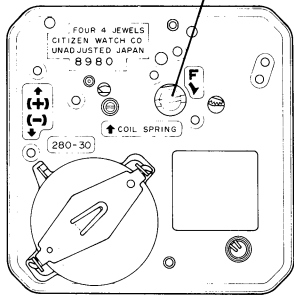
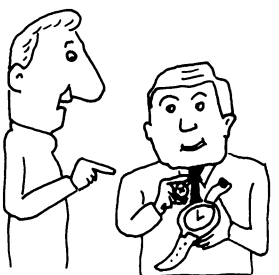
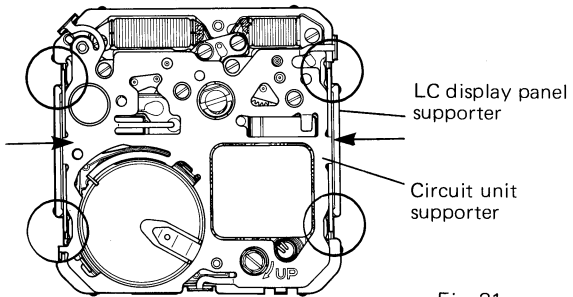
Checking items	How to check	Results and treatment
<p>7 Measurement and adjustment of time rate</p>	<p>a) Measurement of time rate                      For the digital section, the measured value will easily become unstable owing to the 3-split multiplex drive.                      For the analog section, set the range of measurement at 2 sec. The measurement is possible regardless of the display on the 2nd analog watch.</p> <p>b) Adjustment of time rate                      The accuracy of this watch is <math>\pm 15</math> sec. per month at the normal temperatures.                      The time rate is adjusted by turning a trimmer condenser (silver color).                      In this case, a gold-colored trimmer condenser (for temp. add.) is also visible if the device cover is removed.                      So that be careful not to get confused with these two trimmer condensers.                      * If the gold-colored trimmer condenser (for temp. add.) is turned, the thermometer will go wrong.                      * You will not be confused with these two trimmer condensers unless you remove the device cover.</p>	<p>Trimmer condenser (Silver color)                      (Clockwise turn: gains of time)</p>  <p>Fig. 29</p>
<p>8 Confirmation of using condition of watch</p>	<p>Check the following points related to the use of a watch with its user.</p> <ul style="list-style-type: none"> <li>● Did the user use his watch in a wrong way?</li> <li>● What about the environment in which the watch was used?</li> <li>● When did the user carry out the replacement of power cell last?</li> <li>● And other factors related to the use of the watch.</li> </ul>	 <p>Fig. 30</p>
<p>9 Check of switch mechanism</p>	<p>Make sure of the state of contact between each switch spring and the unit of electronic circuit. No correct working may not be secured if the assembling is not perfect between the circuit unit supporter and the LC display panel supporter.</p>  <p>Fig. 31</p> <p>○ : Switch part                      ➔ : Assembling part between switch spring part and LC display panel supporter (2 areas)</p>	<p>Stains at switch part                      ➔ To be cleared off</p> <p>Incomplete assembling                      ➔ To be assembled again</p> <p>Malformation of circuit unit supporter                      ➔ To be repaired or replaced</p> <p>Defective pattern of unit of electronic circuit                      ➔ Replacement of unit of electronic circuit</p>

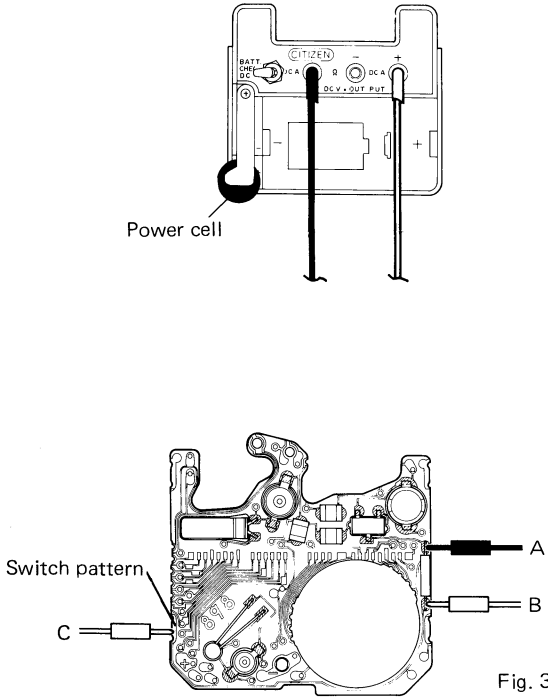
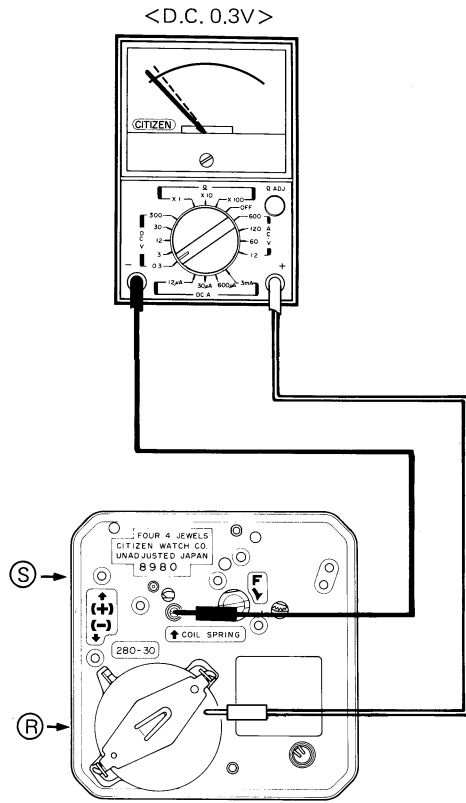

Checking items	How to check	Results and treatment
<p><b>10</b> Check of illumination lamp</p>	 <p style="text-align: right;">Fig. 32</p>	<p>Inspection between A and B: Lighting → Nondefective</p> <p>No lighting → Break of filament</p> <p>Inspection between A and C: Lighting → Nondefective</p> <p>No lighting → Break of circuit pattern</p> <p>Some fault detected through above checks → Replacement of unit of electronic circuit</p>
<p><b>11</b> Check of alarm mechanism</p>	<p>Both (R) and (S) buttons are pushed at one time in the mode of the ordinary time display.</p>  <p style="text-align: center;">Fig. 33</p>	<p>Tester pointer swinging at about 0.05V → Nondefective</p> <p>No alarm output confirmed at all → Replacement of unit of electronic circuit</p>

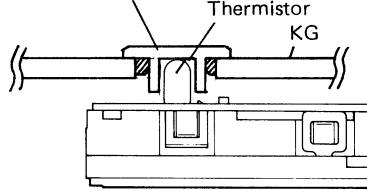
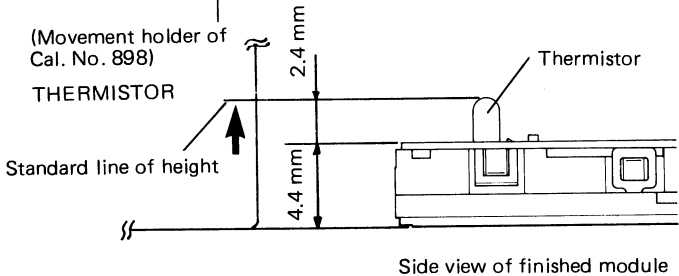
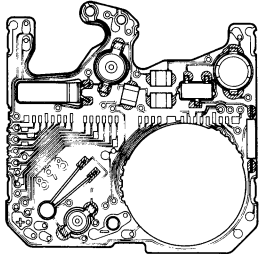
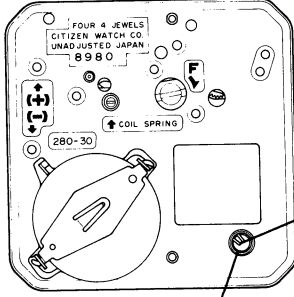
Checking items	How to check	Results and treatment
<p><b>12</b> Check of thermometer mechanism</p>	<p>a) The temperature is continuously bar-displayed if the thermistor has a short circuit or the thermometer system itself has some fault.</p> <p>In such case, the unit of electronic circuit must be replaced with new one. However, the display of the bar mode does not mean a fault at all in the following cases.</p> <ol style="list-style-type: none"> <li>(1) In the case of a temperature outside a prescribed range of measurement.</li> <li>(2) In the case of the temperature memory mode and in the state before actuation of the memory.</li> </ol> <p>The above confirmation must always be performed in a state under which the °C or °F mark is flashing every second.</p> <p>b) The temperature indicating value has some shift:</p> <p>It may be rare to have a correct standard available on the general market in terms of the temperature. In this connection, the condition in which the customer measured the temperature must be confirmed after understanding well the contents of Section 5-3.</p> <p>Then the following points are checked if some fault is detected.</p> <ol style="list-style-type: none"> <li>(1) The state of assembly is examined between the thermistor and a temperature-sensitive plate.</li> </ol> <p>As shown in Fig. 36, the thermistor touches a temperature-sensitive plate. If the contact is incomplete between these two parts, the temperature response properties may sometimes be deteriorated.</p> <p>The positioning of the thermistor must be thoroughly examined in the state of a module.</p> <p>[CAL. 8980/8981]</p> <p>Temperature-sensitive plate</p> <p>Thermistor KG</p>  <p>Fig. 35</p> <p>(Movement holder of Cal. No. 898) THERMISTOR</p> <p>Standard line of height</p> <p>2.4 mm</p> <p>4.4 mm</p> <p>Thermistor</p> <p>Side view of finished module</p>  <p>Fig. 36</p>	<p>Short circuit of lead wire of thermistor → To be repaired</p> <p>Repair impossible → Replacement of unit of electronic circuit</p>  <p>Thermistor lead wire</p> <p>Fig. 34</p>  <p>Thermistor</p> <p>Make sure the thermistor can be viewed at the center of a through-hole.</p>

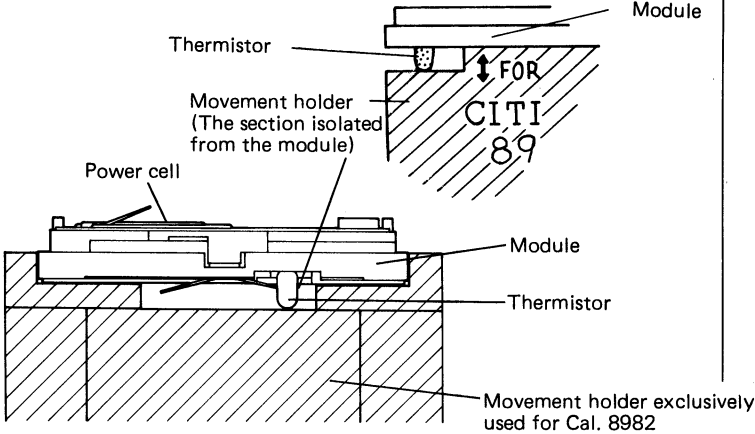
Checking items	How to check	Results and treatment
	<p>The positioning of the thermistor is confirmed in the same way as mentioned in a) of Section 7-2.</p> <p>If the positioning is defective, a correction is given to the thermistor lead wire by means of a tweezers.</p> <p>The movement holder of "898" contains a standard line of height of the thermistor for the convenience when the height of the thermistor is confirmed in the state of a module.</p> <p>[CAL. 8982]</p>  <p>The above illustration is a view of the module mounted onto the movement holder with its power cell section facing upward, and the view is obtained from the direction of the bottom of the face (6 Hour mark) of the watch.</p> <p>The module should be mounted on the movement holder in a correct way, as illustrated above, making sure that the tip of the thermistor maintains a light contact with the upper surface of the section of the movement holder which is isolated from the module. At this time, make sure that the thermistor is almost perpendicular to the module.</p>	

Checking items	How to check	Results and treatment
	<p>(2) Adjustment of temperature</p> <p>The adjustment of temperature is carried out in the following sequence.</p> <ul style="list-style-type: none"> <li>● Remove the device cover.</li> <li>● Set the thermometer in a display mode of 1-second sampling.</li> <li>● Adjust the temperature by turning the trimmer condenser (for temp. add.).</li> </ul> <p>* Avoid giving the effect of the body heat to the thermistor.</p> <p>* An accurate adjustment is impossible if the thermistor is put into the watch case.</p> <p>* Put a standard thermometer and a module close to each other as much as possible.</p> <p>* Leave the thermistor after the adjustment in order to avoid the effect of the body heat. Then confirm the display of the temperature.</p> <p>* In case the thermometer is shifted automatically to the 1-minute sampling mode, push <math>\text{\textcircled{R}}</math> button (in a state of the switch spring only) to switch the 1-minute sampling mode to the 1-second sampling mode. (Be careful of the flashing of the <math>^{\circ}\text{C}</math> and <math>^{\circ}\text{F}</math> marks.)</p> <div style="text-align: center;">  <p>Silver-colored trimmer condenser (for time add.)</p> <p>Gold-colored trimmer condenser (for temp. add.)</p> </div>	<p>Adjustment of temp. impossible</p> <p>→ Replacement of unit of electronic circuit</p> <p>* Adjustment of temp. is already given to the unit of electronic circuit as a repair parts.</p>

Fig. 37

Checking items	How to check	Results and treatment
<p>13 Measurement of power consumption</p>	<p style="text-align: center;">&lt;D.C. 12<math>\mu</math>A&gt;</p>  <p style="text-align: center;">Power cell</p>  <p style="text-align: center;">Fig. 38</p> <p style="text-align: center;">These positions are also effective for measurement in case the original positions are not convenient.</p> <p>*When a load compensating circuit is active, the value of power consumption will increase by about 1<math>\mu</math>A. The load compensating circuit is cancelled in maximum one minute as long as the 2nd analog watch has a normal movement of the hand.</p>  <p style="text-align: center;">Short circuit to be checked between LC display panel holder and thermistor</p> <p style="text-align: center;">Thermistor</p> <p style="text-align: center;">Fig. 39</p>	<p>With finished module:</p> <p style="border: 1px solid black; padding: 2px; display: inline-block;"><b>Under 3.6<math>\mu</math>A</b></p> <p>→ Nondefective</p> <p>With LC display panel removed if over the above value:</p> <p style="border: 1px solid black; padding: 2px; display: inline-block;"><b>Under 1.5<math>\mu</math>A</b></p> <p>→ Replacement of LC display panel</p> <p>*Otherwise the unit of electronic circuit is replaced.</p> <p>* Power consumption to increase with short circuit of thermistor</p> <p>Short circuit of thermistor</p> <p>→ To be repaired</p>

Checking items	How to check	Results and treatment
<p>14 Check of appearance and functions</p>	<ul style="list-style-type: none"> <li>● The external appearance of the watch is perfect with no defect at all.</li> <li>● The controllability of the watch is excellent.</li> <li>● Each function of the watch works in a smooth and correct way.</li> </ul> <div style="text-align: center;">  <p>Fig. 40</p> </div> <p>* All segments on the watch face glow about 2 seconds with a simultaneous push of (M), (S) and (R) buttons. After this, the checking mode for factory is automatically obtained.</p> <p>In this case, however, some error of time may sometimes be caused.</p> <p>* The alarm sound monitor is obtained with a simultaneous push of (S) and (R) buttons.</p> <p>* The all-reset mode is obtained with a simultaneous push of all push-buttons.</p>	

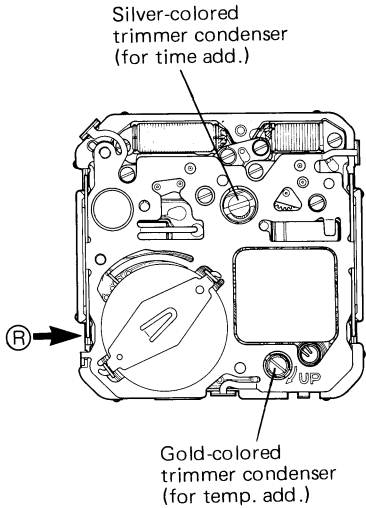
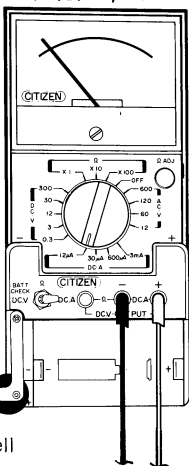
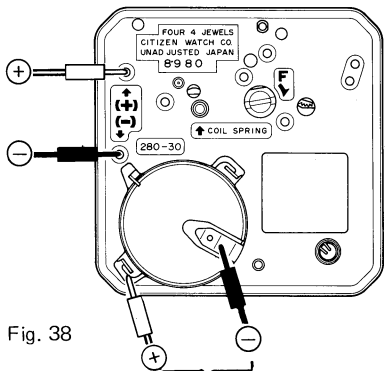
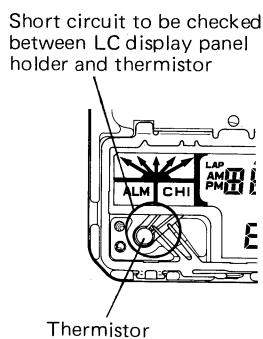
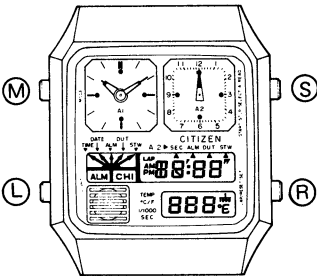

**CITIZEN WATCH CO., LTD.**  
Tokyo, Japan